

SIM4000

Sensor Integration Machine



Described product

SIM4000

Manufacturer

SICK AG
Erwin-Sick-Str. 1
79183 Waldkirch
Germany

Legal information

This work is protected by copyright. Any rights derived from the copyright shall be reserved for SICK AG. Reproduction of this document or parts of this document is only permissible within the limits of the legal determination of Copyright Law. Any modification, abridgment or translation of this document is prohibited without the express written permission of SICK AG.

The trademarks stated in this document are the property of their respective owner.

© SICK AG. All rights reserved.

Original document

This document is an original document of SICK AG.



Contents

1	About this document.....	5
1.1	Information on the operating instructions.....	5
1.2	Explanation of symbols.....	5
1.3	Further information.....	6
2	Safety information.....	7
2.1	General safety notes.....	7
2.2	Intended use.....	7
2.3	Improper use.....	7
2.4	Internet protocol (IP) technology.....	8
2.5	Limitation of liability.....	8
2.6	Modifications and conversions.....	8
2.7	Requirements for skilled persons and operating personnel.....	9
2.8	Operational safety and particular hazards.....	9
3	Product description.....	11
3.1	Device view.....	11
3.2	Functionality.....	11
3.3	Product features and functions.....	12
3.4	Preset Ethernet interfaces.....	12
4	Transport and storage.....	14
4.1	Transport.....	14
4.2	Transport inspection.....	14
4.3	Storage.....	14
5	Mounting.....	15
5.1	Overview of mounting procedure.....	15
5.2	Scope of delivery.....	15
5.3	Preparing for mounting.....	15
5.4	Mounting the device.....	16
5.5	Mounting the device (at a critical ambient temperature of max. 50 °C).....	17
6	Electrical installation.....	20
6.1	Important information.....	20
6.2	Preparing the electrical installation.....	20
6.3	Assembling the cables (optional).....	20
6.4	Overview of connections.....	21
6.5	Pin allocation of the connections.....	22
6.6	Connecting peripheral devices.....	30
7	Commissioning.....	31
7.1	Preparatory commissioning.....	31

8	Operation.....	32
8.1	Status LEDs.....	32
9	Maintenance.....	38
9.1	Cleaning.....	38
9.2	Maintenance plan.....	38
10	Decommissioning.....	39
10.1	Disposal.....	39
11	Technical data.....	40
11.1	Features.....	40
11.2	Interfaces.....	40
11.3	Mechanics and electronics.....	41
11.4	Ambient data.....	42
12	Annex.....	44
12.1	Dimensional drawings.....	44
12.2	Licenses.....	45

1 About this document

1.1 Information on the operating instructions

These operating instructions provide important information on how to use devices from SICK AG.

Prerequisites for safe work are:

- Compliance with all safety notes and handling instructions supplied.
- Compliance with local work safety regulations and general safety regulations for device applications

The operating instructions are intended to be used by qualified personnel and electrical specialists.



NOTE

Read these operating instructions carefully to familiarize yourself with the device and its functions before commencing any work.

The operating instructions are an integral part of the product. Store the instructions in the immediate vicinity of the device so they remain accessible to staff at all times. Should the device be passed on to a third party, these operating instructions should be handed over with it.

These operating instructions do not provide information on operating the machine or system in which the device is integrated. For information about this, refer to the operating instructions of the specific machine.

1.2 Explanation of symbols

Warnings and important information in this document are labeled with symbols. Signal words introduce the instructions and indicate the extent of the hazard. To avoid accidents, damage, and personal injury, always comply with the instructions and act carefully.



DANGER

... indicates a situation of imminent danger, which will lead to a fatality or serious injuries if not prevented.



WARNING

... indicates a potentially dangerous situation, which may lead to a fatality or serious injuries if not prevented.



CAUTION

... indicates a potentially dangerous situation, which may lead to minor/slight injuries if not prevented.



NOTICE

... indicates a potentially harmful situation, which may lead to material damage if not prevented.



NOTE

... highlights useful tips and recommendations as well as information for efficient and trouble-free operation.

1.3 Further information



NOTE

Further documentation for the device can be found on the online product page at:

- www.sick.com/SIM4000

There, additional information has been provided depending on the product, such as:

- Model-specific online data sheets for device types, containing technical data, dimensional drawing, and specification diagrams
 - EU declarations of conformity for the product family
 - Dimensional drawings and 3D CAD dimension models of the device types in various electronic formats
 - Other publications related to the devices described here
 - Publications dealing with accessories
-

2 Safety information

2.1 General safety notes

The following safety notes must always be observed regardless of specific application conditions:

- The device must only be mounted, commissioned, operated, and maintained by professionally qualified safety personnel.
- Electrical connections with peripheral devices must only be made when the voltage supply is disconnected.
- The device is only to be operated when mounted in a fixed position.
- The device voltage supply must be protected in accordance with the specifications.
- The specified ambient conditions must be observed at all times.
- The electrical connections to peripheral devices must be screwed on correctly.
- The cooling fins must not be covered or restricted in their functionality.
- The pin assignment of pre-assembled cables must be checked and adjusted if necessary.
- These operating instructions must be made available to the operating personnel and kept ready to hand.

2.2 Intended use

The device is a programmable control and evaluation unit for sensors and image processing devices. The device also acts as a link between system and plant controls, and the connected terminal devices. The device is mainly used in an industrial environment in production, testing, and control. Other applications are possible depending on the device-specific properties.

The device is programmed on a PC by using the development environment software SICK AppSpace. Depending on the application, a browser-based, graphical user interface (HMI) can be created, which provides opportunities defined by the application developer to influence an application at operator level.

The device connection to the peripherals is established by means of a range of industrial fieldbuses and other interfaces.

The device offers various interfaces for controlling, programming, and operating purposes, which can be activated as necessary via development environments, control systems (programmable logic controllers), or applications.

However, configuration, programming, and control requires various technical skills, depending on how the device is connected and used.

2.3 Improper use

Any use outside of the stated areas, in particular use outside of the technical specifications and the requirements for intended use, will be deemed to be incorrect use.

- The device does not constitute a safety component in accordance with the respective applicable safety standards for machines.
- The device must not be used in explosion-hazardous areas, in corrosive environments or under extreme environmental conditions.
- Any use of accessories not specifically approved by SICK AG is at your own risk.



WARNING

Danger due to improper use!

Any improper use can result in dangerous situations.

Therefore, observe the following information:

- Product should be used only in accordance with its intended use.
 - All information in these operating instructions must be strictly observed.
 - Shut down the product immediately in case of damage.
-

2.4 Internet protocol (IP) technology



NOTE

SICK uses standard IP technology in its products. The emphasis is placed on availability of products and services.

SICK always assumes the following prerequisites:

- The customer ensures the integrity and confidentiality of the data and rights affected by its own use of the aforementioned products.
 - In all cases, the customer implements the appropriate security measures, such as network separation, firewalls, virus protection, and patch management.
-

2.5 Limitation of liability

Relevant standards and regulations, the latest technological developments, and our many years of knowledge and experience have all been taken into account when compiling the data and information contained in these operating instructions. The manufacturer accepts no liability for damage caused by:

- Non-adherence to the product documentation (e.g., operating instructions)
- Incorrect use
- Use of untrained staff
- Unauthorized conversions or repair
- Technical modifications
- Use of unauthorized spare parts, consumables, and accessories

With special variants, where optional extras have been ordered, or owing to the latest technical changes, the actual scope of delivery may vary from the features and illustrations shown here.



NOTE

Programmable device

The Sensor Integration Machine (SIM) is a programmable device.

Therefore, the respective programmer is responsible for his/her programming performance and the resulting operating principle of the device.

The liability and warranty of SICK AG is limited to the device specification (hardware functionality and any programming interfaces) according to the agreed conditions.

Therefore, SICK AG is not liable, among other things, for damages that are caused by programming of the customer or third parties.

2.6 Modifications and conversions



NOTICE

Modifications and conversions to the device may result in unforeseeable dangers.

Interrupting or modifying the device or SICK software will invalidate any warranty claims against SICK AG. This applies in particular to opening the housing, even as part of mounting and electrical installation.

2.7 Requirements for skilled persons and operating personnel



WARNING

Risk of injury due to insufficient training.

Improper handling of the device may result in considerable personal injury and material damage.

- All work must only ever be carried out by the stipulated persons.

This product documentation refers to the following qualification requirements for the various activities associated with the device:

- **Instructed personnel** have been briefed by the operator about the tasks assigned to them and about potential dangers arising from improper action.
- **Skilled personnel** have the specialist training, skills, and experience, as well as knowledge of the relevant regulations, to be able to perform tasks delegated to them and to detect and avoid any potential dangers independently.
- **Electricians** have the specialist training, skills, and experience, as well as knowledge of the relevant standards and provisions, to be able to carry out work on electrical systems and to detect and avoid any potential dangers independently. The electrician must comply with the provisions of the locally applicable work safety regulation.

The following qualifications are required for various activities:

Table 1: Activities and technical requirements

Activities	Qualification
Mounting, maintenance	<ul style="list-style-type: none"> ■ Basic practical technical training ■ Knowledge of the current safety regulations in the workplace
Electrical installation, device replacement	<ul style="list-style-type: none"> ■ Practical electrical training ■ Knowledge of current electrical safety regulations ■ Knowledge of the operation and control of the devices in their particular application
Commissioning, configuration	<ul style="list-style-type: none"> ■ Basic knowledge of the Windows™ operating system in use ■ Basic knowledge of the design and setup of the described connections and interfaces ■ Basic knowledge of data transmission
Operation of the device for the particular application	<ul style="list-style-type: none"> ■ Knowledge of the operation and control of the devices in their particular application ■ Knowledge of the software and hardware environment for the particular application

2.8 Operational safety and particular hazards

Please observe the safety notes and the warnings listed here and in other chapters of this product documentation to reduce the possibility of risks to health and avoid dangerous situations.



WARNING

Electrical voltage!

Electrical voltage can cause severe injury or death.

- Work on electrical systems must only be performed by qualified electricians.
 - The power supply must be disconnected when attaching and detaching electrical connections.
 - The product must only be connected to a voltage supply as set out in the requirements in the operating instructions.
 - National and regional regulations must be complied with.
 - Safety requirements relating to work on electrical systems must be complied with.
-



WARNING

Risk of injury and damage caused by potential equalization currents!

Improper grounding can lead to dangerous equipotential bonding currents, which may in turn lead to dangerous voltages on metallic surfaces, such as the housing. Electrical voltage can cause severe injury or death.

- Work on electrical systems must only be performed by qualified electricians.
 - Follow the notes in the operating instructions.
 - Install the grounding for the product and the system in accordance with national and regional regulations.
-

2.8.1 LED RGO

The product is fitted with LEDs in risk group 0. The accessible radiation from these LEDs does not pose a danger to the eyes or skin.

3 Product description

3.1 Device view

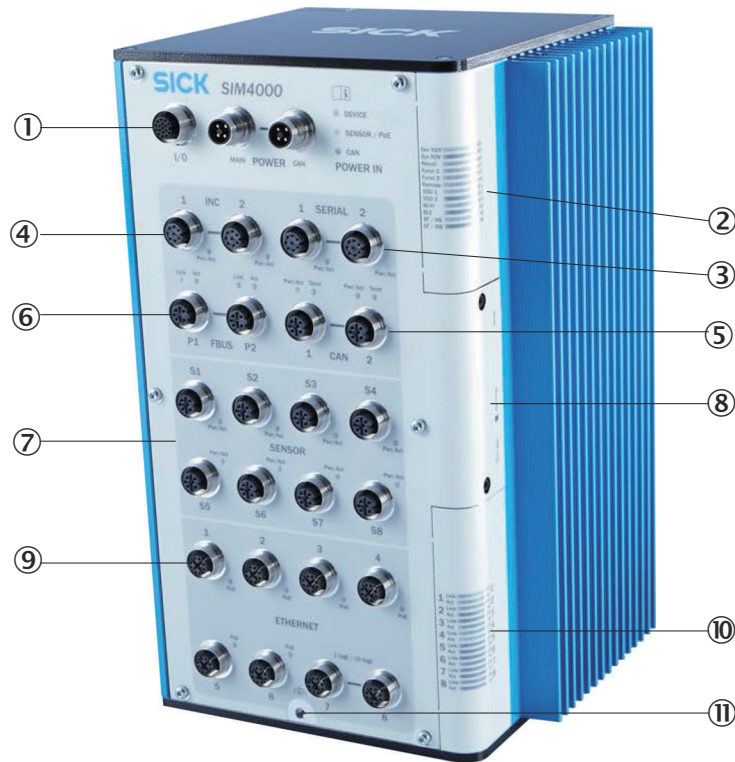

- ① Power and I/O connections
- ② Device status indicators
- ③ Serial connections
- ④ Incremental connections
- ⑤ CAN connections
- ⑥ Fieldbus connections
- ⑦ (IO-Link) sensor connections
- ⑧ Servicing panel
- ⑨ Ethernet connections
- ⑩ Status indicators for Ethernet and fieldbus connections
- ⑪ Functional ground connection

3.2 Functionality

The SIM4000 Sensor Integration Machine – part of the SICK AppSpace ecosystem – is opening up new possibilities for application solutions.

Data from SICK sensors such as laser scanners and cameras can be merged into a point cloud, evaluated, archived, and transmitted. 8 Gigabit Ethernet interfaces are available for 2D or 3D cameras, and in some cases feature a voltage supply over Ethernet (PoE).

Other sensors can be integrated via IO-Link, for example for distance and height measuring purposes.

Fieldbus and Ethernet interfaces with OPC-UA and MQTT provide data preprocessed in “dual talk” (edge computing) for the controller and for cloud computing. In addition, the SIM can be integrated into a SICK CAN sensor network.

Thanks to the high-performance multi-core processor featuring hardware support, the SIM4000 enables image (pre)processing and handling of input and output signals in real time. The integrated HALCON image processing library, plus the open SICK AppSpace software platform, make it possible to develop customized application programs for even the most demanding 2D and 3D machine vision applications.

The HMI and data visualization features can be provided on any browser-enabled notebook, PC, or tablet. The app is created using the SICK AppStudio SDKs and - when using HALCON - using HDevelop from MVTec.

3.3 Product features and functions

3.3.1 Functions

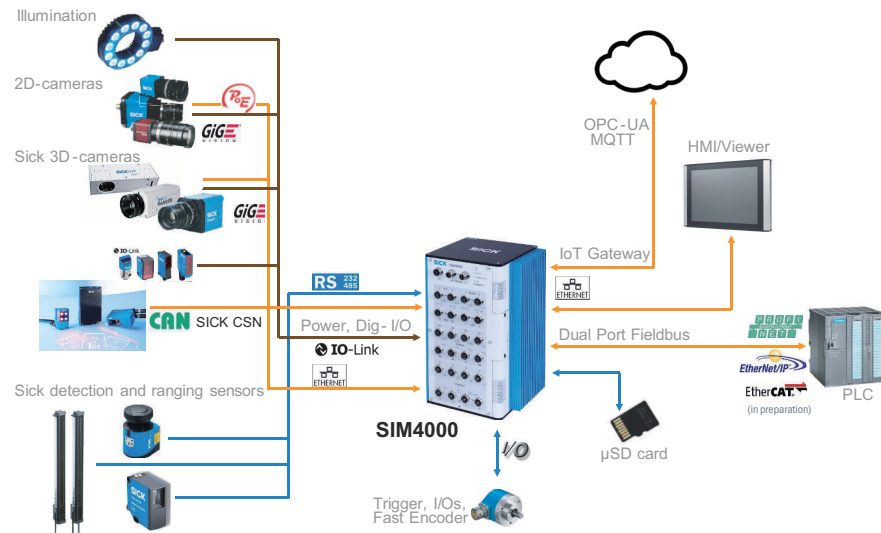

3.3.2 SICK AppSpace



Detailed instructions on the SICK AppStudio as well as programming the device can be found at supportportal.sick.com.

3.4 Preset Ethernet interfaces



NOTE

Preset IP addresses of the ETHERNET interfaces:

- ETHERNET 1: 192.168.0.1
- ETHERNET 2: 192.168.1.1
- ETHERNET 3: 192.168.2.1
- ETHERNET 4: 192.168.3.1
- ETHERNET 5: 192.168.4.1
- ETHERNET 6: 192.168.5.1
- ETHERNET 7: 192.168.6.1
- ETHERNET 8: 192.168.7.1

- When expanding the 1 GigE interfaces with one or more Ethernet switches, it is essential to use only jumbo-frame compatible 1 GigE switches. Switches limited to just 100 Mb do not support the data packet mode used by cameras and can cause transmission errors.

Changing the IP addresses

The individual IP addresses can be changed using the “WelcomeAPP” pre-installed in the device or via the SICK “SOPAS-ET” PC tool.

4 Transport and storage

4.1 Transport

For your own safety, please read and observe the following notes:



NOTICE

Damage to the product due to improper transport.

- The device must be packaged for transport with protection against shock and damp.
 - Recommendation: Use the original packaging as it provides the best protection.
 - Transport should be performed by trained specialist staff only.
 - The utmost care and attention is required at all times during unloading and transportation on company premises.
 - Note the symbols on the packaging.
 - Do not remove packaging until immediately before you start mounting.
-

4.2 Transport inspection

Immediately upon receipt in Goods-in, check the delivery for completeness and for any damage that may have occurred in transit. In the case of transit damage that is visible externally, proceed as follows:

- Do not accept the delivery or only do so conditionally.
 - Note the scope of damage on the transport documents or on the transport company's delivery note.
 - File a complaint.
-



NOTE

Complaints regarding defects should be filed as soon as these are detected. Damage claims are only valid before the applicable complaint deadlines.

4.3 Storage

Store the device under the following conditions:

- Recommendation: Use the original packaging.
- Do not store outdoors.
- Store in a dry area that is protected from dust.
- So that any residual damp can evaporate, do not package in airtight containers.
- Do not expose to any aggressive substances.
- Protect from sunlight.
- Avoid mechanical shocks.
- Storage temperature: see "Technical data", page 40.
- For storage periods of longer than 3 months, check the general condition of all components and packaging on a regular basis.

5 Mounting

5.1 Overview of mounting procedure

**NOTE**

The mounting procedure described here for the device meets the requirements for use in the target system.

Additional or different requirements may become necessary in the laboratory and during preparation, and should be taken into account as necessary, see "Commissioning", page 31. If you have any questions or anything remains unclear in this regard, please contact our service team.

- Mounting the bracket, if provided.
- Mounting the device.
- Connect the cables.
- Connecting peripheral devices.
- Connecting the voltage supply.

5.2 Scope of delivery

- SIM4000
- 1x grounding screw
- 1x toothed lock washer
- 6x sliding nuts
- Safety note
- Optional: ordered accessories

**NOTE**

For a list of cables suitable for use with the device, see: supportportal.sick.com.

5.3 Preparing for mounting

Mounting requirements

**NOTE**

It is recommended to mount the device using the adapter holding plate (part no. 2083419) which is available as an accessory. The following specific mounting instructions must be taken into consideration if the device will be used at elevated ambient temperatures up to max. 50 °C, see "Mounting the device (at a critical ambient temperature of max. 50 °C)", page 17.

- Select the mounting site: Plan space requirements and sufficient distance from other devices. Be aware of the possibility of heat dissipation.
- Unpack the device and allow to acclimatise to avoid formation of condensation.

Preparing for mounting with holding plate

**NOTE**

The device can also be mounted onto an aluminum profile without holes.

1. Place the holding plate at the mounting site.
2. Mark the mounting holes.
3. Proceed to drill the mounting holes.

5.4 Mounting the device

Mounting the device using the adapter holding plate, available as an accessory

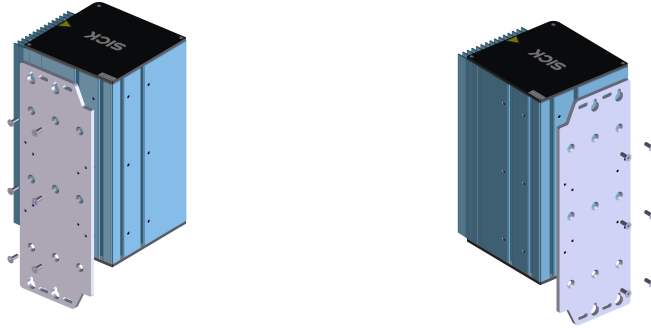

1. Mount the holding plate on SIM4000 using the supplied screws.
2. Place SIM4000 with the holding plate on the mounting site.



3. Secure the holding plate by tightening the 3 screws.



4. Alternatively: Pre-mount the 4 screws for suspended mounting and mount the holding plate with the device.

**NOTICE**

Use self-locking or lock nuts on mounting sites that are exposed to vibrations to prevent the holding plate from loosening.

5.5 Mounting the device (at a critical ambient temperature of max. 50 °C)

**NOTICE**

To prevent damage to the device or the attached peripheral devices at high ambient temperatures of a maximum of 50 °C, the following extended installation conditions must be taken into account when mounting the device.

Prerequisites:

- Device is mounted vertically (device name on top)
- Mounting takes place using the supplied sliding nuts and the holding plate, which is available as an accessory
- Aluminum profiles for mounting on the system (min. 1,200 mm in length)
- No direct sunlight and heat radiation
- Distance to other components or housing walls: min. 400 mm (above, below, to the left), min. 500 mm (on the heat-sink side)

Degradation of ambient temperature

Depending on the following device configurations, degradation of the permitted ambient temperature must be taken into account:

- CPU load $\geq 75\%$ (can be read using SICK AppStudio)
- PoE load ≥ 25 W (load of attached camera)
- Load at voltage/switching outputs ≥ 100 W

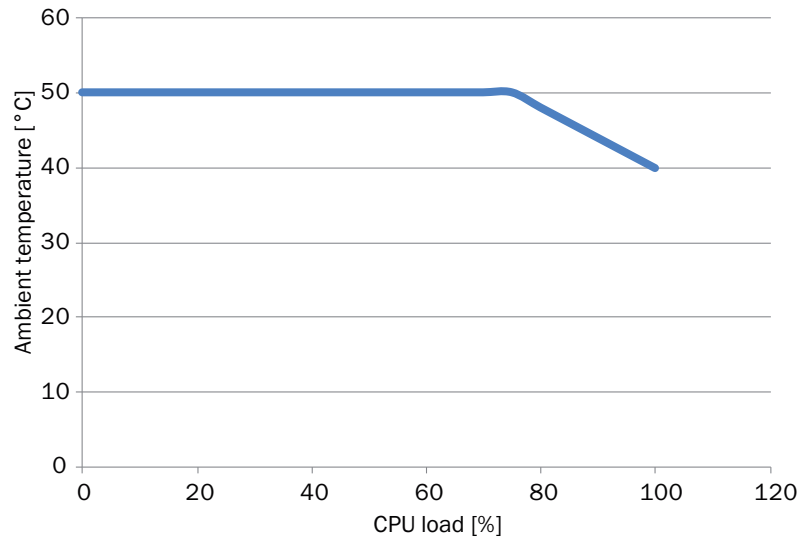

Figure 1: Degradation of ambient temperature depending on the CPU capacity

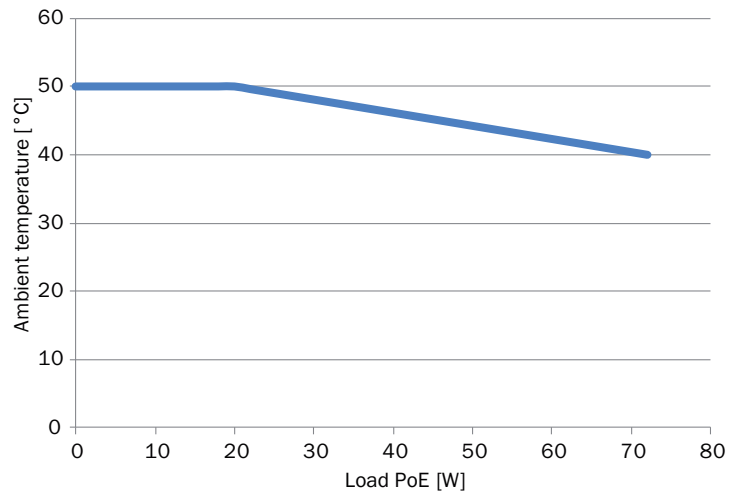

Figure 2: Degradation of ambient temperature depending on the PoE load

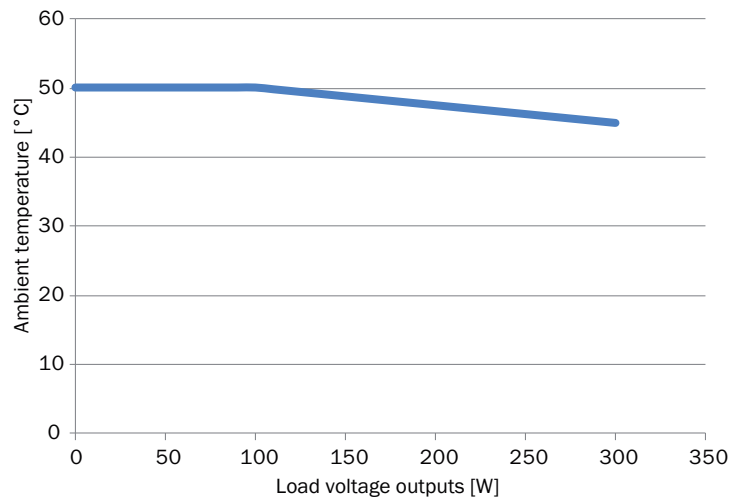
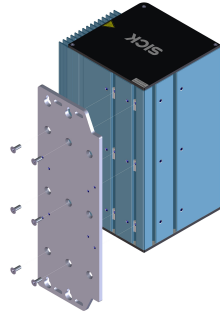

Figure 3: Degradation of ambient temperature depending on the load on the voltage outputs

Mounting steps

1. Click the three sliding nuts into place into each of the vertical slots.



2. Screw the holding plate (or equivalent) to the sliding nuts with 6 screws.
3. Fit the device with the holding plate on the aluminum profile.



CAUTION

Danger from hot surfaces

An ambient temperature greater than 45 °C can lead to contact-critical heat in the lateral heat sink. It must be therefore be ensured that accidental contact is unlikely.



NOTE

Using an external fan (part number 2089755), the maximum ambient operating temperature of the device can be increased from +50 °C to +60 °C. The fan is available as an accessory at www.sick.com.

6 Electrical installation

6.1 Important information



WARNING

Risk of injury and damage caused by electrical current!

Due to equipotential bonding currents, incorrect earthing can lead to the following dangers and faults: Voltage is applied to the metal housing, cable fires due to cable shields heating up, the product and other devices become damaged.

- Generate the same ground potential at all grounding points.
- Ground the equipotential bonding via the functional ground connection with a low impedance (use standard cable lug with M4 hole).



NOTICE

Device damage due to improper supply voltage!

- Only operate the device with the specified supply voltage.
- The voltage supply and all connected signals must meet the requirements for extra-low voltages with safe separation (SELV/PELV) as specified in EN 61010. The external voltage supply of the device must bridge a short-term power interruption of 20 ms in order to meet the requirements of EN 60204-1.
- All circuits connected to the device must be designed as SELV circuits (in accordance with EN 60950-1 or ES1 EN 62368-1).



NOTE

Layout of data cables

- Use screened data cables with twisted-pair wires.
- Implement the screening design correctly and completely.
- To avoid interference, e.g. from switching power supplies, motors, clocked drives, and contactors, always use cables and layouts that are suitable for EMC.
- Do not lay cables over long distances in parallel with power supply cables and motor cables in cable channels.

6.2 Preparing the electrical installation

To carry out the electrical installation, you will need:

- Connection cables for the peripheral devices, including the corresponding data sheets
- Voltage supply cable
- If customers assemble the cables: crimping tool, ferrules, soldering iron, and other installation material

6.3 Assembling the cables (optional)

For a list of cables suitable for use with the device, see the document “SIMxxxx_Cable-Overview” available from supportportal.sick.com.

Customer assembly of the cables is only necessary in special cases. Ensure a sufficient length of cable is provided, e.g., for strain-relief clamps.

**NOTICE****Risk of damage/malfunction due to incorrect PIN assignment**

Incorrect wiring of the male connectors/female connectors can lead to damage to or malfunctions in the system.

- Observe data sheets provided by the cable manufacturer.
- Observe the pin assignment.

6.4 Overview of connections

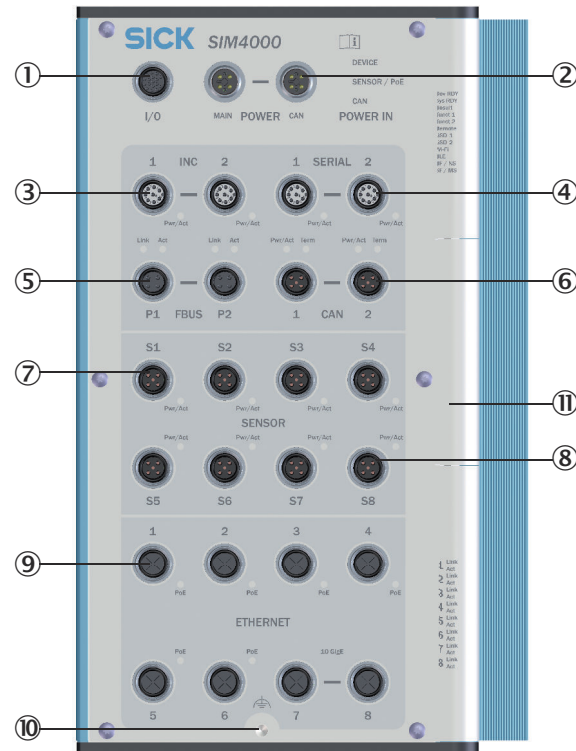

Figure 4: Overview of connections

- ① **I/O:** Universal port with configurable inputs/outputs and opto-decoupled inputs as well as a voltage supply for peripherals
- ② **POWER:** Voltage supply inputs
- ③ **INC:** Two incremental encoder In/Out or RS-422
- ④ **SERIAL:** One RS-232/RS-422/RS-485 or one INC In/Out and one 1 A LPS voltage supply are available for each connection to peripherals
- ⑤ **FBUS:** Two Ethernet-based fieldbus interfaces
- ⑥ **CAN:** Two connections for the SICK CAN sensor network (receiver/transceiver)
- ⑦ **SENSOR 1-4:** Four sensor connections with two configurable inputs/outputs and one dedicated input
- ⑧ **SENSOR 5-8:** Four IO connections with two configurable inputs/outputs and one dedicated input
- ⑨ **ETHERNET:** Eight Ethernet connections (6 thereof with PoE)
- ⑩ **Functional ground connection:** see note in 6.1
- ⑪ **Servicing panel**

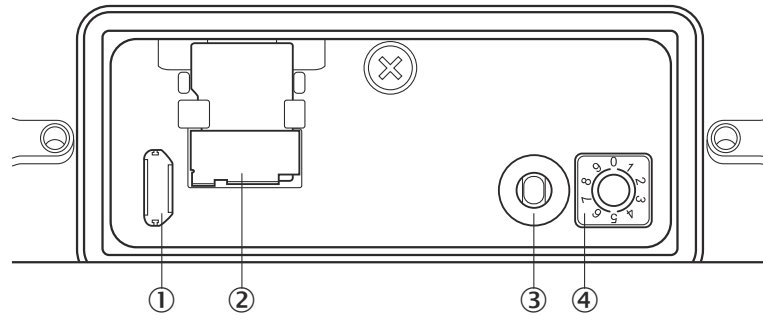

Figure 5: Servicing panel

- ① USB connection (Micro-B, for configuration/diagnostics/firmware update)
- ② microSD card slot
- ③ Function button
- ④ Function selector switch (configurable by SensorApp)

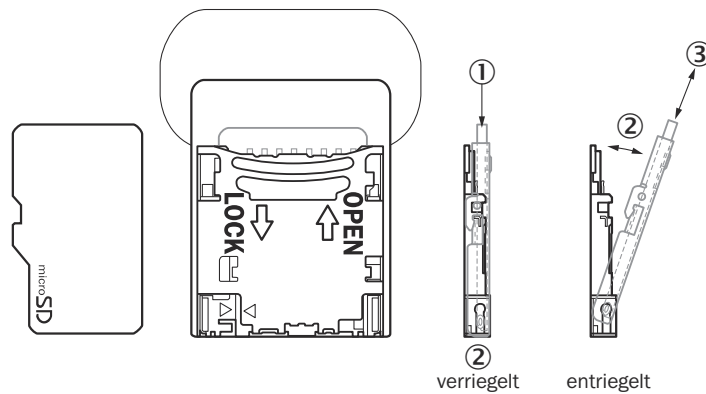

Figure 6: Installing/removing a micro-SD card

- ① Open the servicing panel by removing the two screws.
- ② To install an SD card, first gently press the SD card tray to release ① and then open it ②.
- ③ Now insert the card with the contact side facing down.
- ④ To remove the card, release and open the card tray ② and then pull out the card ③ .

6.5 Pin allocation of the connections

6.5.1 POWER In main/CAN

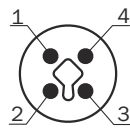

Figure 7: POWER In main/CAN pin assignment, M12 – 4-pin T-coded, male

Table 2: M12 – 4-pin (main, male)

Pin	Signal	Color coding of open-ended SIM cables ¹	Function
1	+24 V IN1 (U _s)	BN (brown)	Supply voltage, system
2	GND IN2	WH (white)	Ground
3	GND IN1	BU (blue)	Ground
4	+24 V IN2 (U _a)	BK (black)	Supply voltage for SENSOR S5-S8 + PoE

Pin	Signal	Color coding of open-ended SIM cables ¹	Function
Housing	-	-	Screen

¹ SICK cables in the SIM4000 accessories

Table 3: M12 – 4-pin (male)

Pin	Signal	Color coding of open-ended SIM cables ¹	Function
1	+24 V IN1 (Us)	BN (brown)	Supply voltage, system
2	GND IN2	WH (white)	Ground
3	GND IN1	BU (blue)	Ground
4	+24 V IN2 (U _a)	BK (black)	Supply voltage, CAN
Housing	-	-	Screen

¹ SICK cables in the SIM4000 accessories

Additional notes:

- Max. 7.5 A permanent load per connection (IN1+IN2)
- System supply voltage can be set up redundantly.
- Power cables must be protected with max. 12 A.

6.5.2 Connecting voltage supply

Block diagram

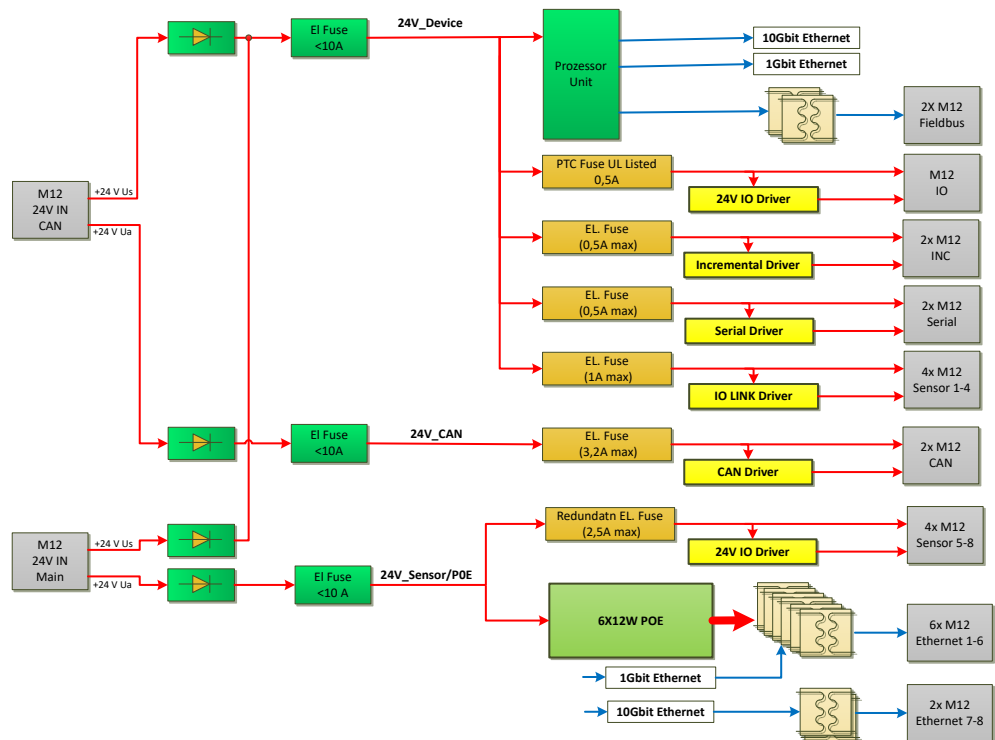

Figure 8: Connection to the power supply



NOTICE

Risk of damage to peripheral devices!

If peripheral devices are connected when the voltage supply is also applied, these devices can become damaged.

- Only connect peripheral devices when the voltage supply is disconnected.

1. Ensure that the voltage has been disconnected by the user.
2. Connect the voltage supply cable(s) to the device.
3. Lay the cable(s) with strain relief.
4. Have the user connect the voltage supply.
5. Have the user activate the voltage.

6.5.3 I/O

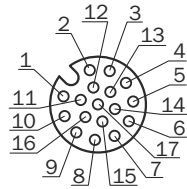

Figure 9: I/O pin assignment, M12 - 17-pin A-coded, female

Table 4: I/O connection

Pin	Signal	Function	Factory settings	Color coding of open-ended SIM I/O cables ¹
1	GND	Ground	-	BU (blue)
2	24 V OUT	Supply voltage, peripherals	Always enabled	BN (brown)
3	Input 5/output 5	Configurable switching input/output	All IO connections as inputs	GN (green)
4	Input 6/output 6	Configurable switching input/output		WH (white)
5	Input 7/output 7	Configurable switching input/output		PK (pink)
6	Input 8/output 8	Configurable switching input/output		BK (black)
7	Input 9/output 9	Configurable switching input/output		BK (black)
8	Input 10/output 10	Configurable switching input/output		GY (gray)
9	Input 11/output 11	Configurable switching input/output		WHBK (white/black)
10	Input 1	Isolated switching input	-	VT (violet)
11	SensGND 1	Isolated GND input 8	-	GYPK (gray/pink)
12	Input 2	Isolated switching input	-	RDBU (red/blue)
13	SensGND 2	Isolated GND input 9	-	WHGN (white/green)
14	Input 3	Isolated switching input	-	BNGN (brown/green)
15	SensGND 3	Isolated GND input 10	-	WHYE (white/yellow)

Pin	Signal	Function	Factory settings	Color coding of open-ended SIM I/O cables ¹
16	Input 4	Isolated switching input	-	YEBN (yellow/brown)
17	SensGND 4	Isolated GND input 11	-	WHGY (white/gray)
Housing	-	Screen	-	

¹ SICK cables in the SIM4000 accessories

Additional notes:

- Connection to control cabinet to connect devices directly
- 7 GPIOs and 4 isolated inputs
- Max. 0.5 A output for supply voltage connection (compliant with LPS)
- Digital outputs can be configured as inputs
- Outputs:
 - Max. current output: 100 mA
 - Min. high output logic level: VCC – 3 V
 - Max. low output logic level: 3 V
 - Push/pull, NPN, PNP configurable
 - Max. output frequency: 10 kHz
- Inputs:
 - Min. high input logic level: 12 V
 - Max. low input logic level: 4 V
 - Input 1 - 4 (isolated): maximum 30 kHz
 - Input 5 - 11: Max. input frequency: 30 kHz

6.5.4 INC

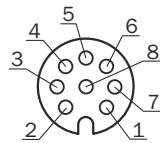

Figure 10: Incremental pin assignment, M12 – 8-pin A-coded, female

Table 5: Incremental connections for encoders, can also be used as serial connections for RS-422

Pin	Mode			
	RS-422*	RS-232	RS-485	INC
1	T-	-	-	A- (in/out)
2	T+	-	-	A+ (in/out)
3	R-	-	-	B- (in/out)
4	R+	-	-	B+ (in/out)
5	-	-	-	Z- (not supported)
6	-	-	-	Z+ (not supported)
7	GND (ground)			
8	24 V (supply voltage for peripherals, configurable, deactivated in factory condition)			
Housing	Screen			

* Standard configuration

Additional notes

- Max. 0.5 A output for supply voltage connections (compliant with LPS)
- Frequency: max. 2 MHz
- TTL encoders use RS422 and can be connected via the INC interface.

6.5.5 SERIAL

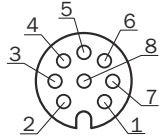

Figure 11: Serial pin assignment, M12 – 8-pin A-coded, female

Table 6: Serial connections, can also be used as an incremental connection

Pin	Mode			
	RS-422	RS-232*	RS-485	INC
1	-	-	-	A- (in/out)
2	-	-	-	A+ (in/out)
3	T-	-	Rx/Tx- (B)	B- (in/out)
4	T+	TxD	Rx/Tx+ (A)	B+ (in/out)
5	R-	-		Z- (not supported)
6	R+	RxD		Z+ (not supported)
7	GND (ground)			
8	24 V (supply voltage for peripherals, configurable, deactivated in factory condition)			
Housing	Screen			

* Standard configuration

Additional notes:

- Max. 1 A output for supply voltage connections (compliant with LPS)
- Data transmission rates:
 - RS-232: 115.2 kBaud
 - RS-422: 2 MBaud
 - RS-485: 2 MBaud
- TTL encoders use RS422 and can be connected via the SERIAL interface.

6.5.6 FBUS

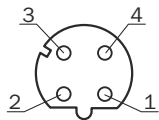

Figure 12: Fieldbus pin assignment, M12 – 4-pin D-coded, female

Table 7: Fieldbus connections

Pin	Signal	Function
1	TD+ (TX1_P)	Transmit data +
2	RD+ (RX1_P)	Receive data +
3	TD- (TX1_N)	Transmit data -
4	RD- (RX1_N)	Receive data -
Housing	-	Screen

Additional notes:

- Designed for line topology
- Data transmission rates: 10/100 Mbit/s
- PROFINET and EtherNet/IP support, EtherCAT® * under development

* EtherCAT® is a registered trademark and patented technology licensed by Beckhoff Automation GmbH, Germany.

6.5.7 CAN

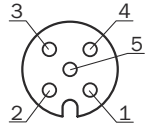

Figure 13: CAN pin assignment, M12 – 5-pin A-coded, female

Table 8: CAN connections

Pin	Signal	Function	Factory settings
1	-	Screen	
2	+24 V	Supply voltage for peripherals, configurable	Deactivated
3	GND	Ground	
4	CAN_H	CAN high	Termination deactivated*
5	CAN_L	CAN low	
Housing	-	Screen	

* Termination controllable via app

Additional notes:

- Max. 3.2 A output for supply voltage connections (compliant with LPS)
- To enable voltage supply to the peripherals, both voltage supply strands from POWER CAN must be connected to 24 V.

6.5.8 SENSOR 1-4

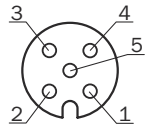

Figure 14: Pin assignment of sensor 1-4, M12 – 5-pin A-coded, female

Table 9: SENSOR 1-4 connections

Pin	Signal	Function	Factory settings
1	+24 V	Supply voltage for peripherals, configurable	Deactivated
2	Input 2	Digital input	-
3	GND	Ground	-
4	C/Q or Input 1 / Output 1	C/Q IO-Link or configurable digital switching input/output	All IO connections configured as inputs
5	NC	Not connected	-
Housing	-	Screen	-

Additional notes:

- 4 x IO-Link master (1x master available per connection)
- The digital inputs and output are only switchable if the supply voltage is activated on pin 1, or +24 V is externally applied to pin 1. A ground connection on pin 3 is required in both cases.
- Digital output:
 - Max. output 100 mA.
 - Min. high output logic level: VCC – 3 V
 - Max. low output logic level: 3 V
 - Push-pull switch
 - Max. IO-Link output frequency: 230 kHz
 - Max. IO output frequency: 30 kHz
- Digital inputs:
 - Min. high input logic level: 12 V
 - Max. low input logic level: 4 V
 - Max. IO-Link input frequency: 230 kHz
 - Max. IO input frequency: 30 kHz
- Max. 1 A output for supply voltage connections S1 to S4 (compliant with LPS)
- HTL encoders use push-pull switches and can therefore be connected via the digital inputs.

Recommendation when using S1 to S4 for illumination:

- Short flash times can be achieved by using an illumination unit with signal strobe and by using pin 4 as a switching output signal with a constant supply voltage on pin 1.

External fan:

A mountable fan guard that is available as an accessory (part number: 2089755) can be connected to S4. This can be used to increase the maximum ambient operating temperature of the device from +50 °C to +60 °C. It is activated via SOPAS-ET or via the GUI of the WelcomeApp of the device. After activation, the fan is automatically switched on or off when the temperature exceeds or falls below a critical temperature.

6.5.9 SENSOR

Illumination control:

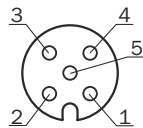

Figure 15: Pin assignment of sensor 5–8, M12 – 5-pin A-coded, female

Table 10: SENSOR 5-8 connections

Pin	Signal	Function	Factory settings
1	+24 V	Supply voltage for peripherals, configurable	Deactivated
2	Input 3	Digital input	–
3	GND	Ground	–
4	Input 1 / output 1	Configurable digital input/output	All IO connections configured as inputs
5	Input 2 / output 2	Configurable digital input/output	All IO connections configured as inputs
Housing	–	Screen	–

Additional notes:

- The digital inputs and outputs are only switchable if the supply voltage is activated on pin 1, or +24 V is externally applied to pin 1. A ground connection on pin 3 is required in both cases.
- Digital outputs:
 - Max. output 100 mA
 - Min. high output logic level: VCC – 3 V
 - Max. low output logic level: 3 V
 - Push-pull switch
 - Max. IO output frequency: 30 kHz
- Digital inputs:
 - Min. high input logic level: 12 V
 - Max. low input logic level: 4 V
 - Max. input frequency for input 3: 10 kHz
 - Max. IO input frequency: 30 kHz
- Max. 2.5 A output for supply voltage connections S5 to S8 (compliant with LPS). To enable voltage supply to the peripherals, both voltage supply strands from POWER MAIN must be connected to 24 V.
- HTL encoders use push-pull switches and can therefore be connected via the digital inputs.

Recommendation when using S5 to S8 for illumination:

Short flash times can be achieved using two alternative modes:

1. Power Strobe Mode: when using the “Connector.Power.Gate” API (see the API documentation)
2. Signal Strobe Mode: when using pin 4 or pin 5 as a switching output signal with a constant supply voltage on pin 1 (only for illumination units with signal strobe).

6.5.10 ETHERNET

Figure 16: Ethernet pin assignment, M12 – 8-pin X-coded, female

Table 11: Ethernet 1-8 connections

Pin	Function
1	D1+ (PoE supply voltage)
2	D1- (PoE supply voltage)
3	D2+ (PoE ground)
4	D2- (PoE ground)
5	D4+
6	D4-
7	D3-
8	D3+

Additional notes:

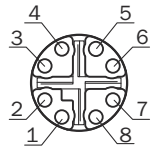
- The Ethernet connections can be used to connect to cameras and SICK LiDAR scanners as well as a PC or network.
- The relevant drivers are implemented in the SIM to enable usage of the SICK LiDAR scanners and picoCam and midiCam camera families as well as cameras compatible with GigE machine vision.

- Jumbo frame support is required when using Ethernet switches.
- Transmission rates:
 - ETH1 - 6: 0.01; 0.1, 1 Gb/s
 - ETH7 - 8: 10 Gb/s
- ETH1 – 6: with class 4 PoE Out
 - PoE power supply is activated by factory setting
- To enable voltage supply to PoE devices, both voltage supply strands from POWER MAIN must be connected to 24 V.

6.6 Connecting peripheral devices

The device can be connected to a wide range of sensors and cameras.

The required pin assignments can be found in the data sheets for the peripherals to be connected as well as in the relevant connection descriptions, [see "Pin allocation of the connections", page 22](#).

1. If necessary, assemble connection cables, [see "Assembling the cables \(optional\)", page 20](#).
2. Connect the cables to peripheral devices.
3. Route the cables to the device using installation materials (cable channels, cable ties, etc.). When doing so, pay attention to cable strain relief.
4. Connect cables to the relevant device connections and screw together tightly.
5. Seal unused connections with dummy plugs.

7 Commissioning

7.1 Preparatory commissioning

Commissioning for preparatory purposes and under laboratory conditions differs in some respects from commissioning in the target system.

In general, all safety and hazard warnings applicable to mounting (see ["Mounting", page 15](#)) and electrical installation (see ["Important information", page 20](#)) must also be observed under laboratory conditions. In addition, further notes must be taken into consideration to guarantee the most effective preparation possible:

- Only connect those devices to the product that you want to configure or program.
- Operate the connected device in a controlled and contained network environment for the time being to check network communication if necessary.
- Note the company standards that apply to the use of checking and testing devices.
- For initial programming, use ideal conditions for sensor or camera recognition.
- Use the largest possible deviations from these ideal conditions to check the programming with respect to its error tolerance and reliability, and to determine error limit values.

Procedure

1. Place the device on a non-slip base.
2. Connect the required peripheral devices, see ["Connecting peripheral devices", page 30](#).
3. Connect the network connection.
4. Connect the voltage supply.
5. Switch on the voltage supply.

8 Operation







8.1 Status LEDs

When the device is operating, the operational status of the connections is indicated visually by status LEDs.

Using these status indicators, the operator can find out quickly and easily whether the device and the peripherals are working properly or whether any faults or errors have occurred.

Monitoring the visual indicators is part of the routine inspection carried out on the device and the machine/plant area into which the device is incorporated.

Meaning of symbols

Symbol	Purpose
	LED off
	LED on
	LED flashes
	LED goes out briefly
	LED lights up briefly
	LED flashes bicolored

8.1.1 Situation and function of the LEDs

Device status

Table 12: Device status indicators

Location	Designation	LED behavior	Indicator		
Dev RDY <input type="checkbox"/> Sys RDY <input type="checkbox"/> Result <input type="checkbox"/> Funct 1 <input type="checkbox"/> Funct 2 <input type="checkbox"/> Remote <input type="checkbox"/> SSD 1 <input type="checkbox"/> SSD 2 <input type="checkbox"/> WIFI <input type="checkbox"/> BLE <input type="checkbox"/> BF / NS <input type="checkbox"/> SF / MS <input type="checkbox"/>	Dev RDY		Device booting		
			Runlevel READY, no errors detected.		
			Runlevel READY, boot process error.		
	Sys RDY Result Funct 1 Funct 2 Remote			User-defined, configurable with AppSpace.	
	SSD 1			Internal SSD connected.	
	SSD 2			Internal SSD connected.	
	WIFI			Currently not supported.	
	BLE			Currently not supported.	
	BF/NS	PROFINET: Bus error (BF)			Fault has occurred
		Ethernet/IP: Network status (NS)			
			Device has an IP address and a CIP connection		
			No connection: Device has an IP address, but no CIP connection		
			Error: IP address has already been assigned to a different device		
			Warning, connection time out; reset by performing a reset or establishing a new connection		
			Self-test when switching on		
			No supply voltage or no IP address		
SF/MS	PROFINET: Group error (SF)			Data exchange via fieldbus	





Location	Designation	LED behavior	Indicator
		Ethernet/IP: Module status (MS)	
			Device in operation
			Standby/device not configured, no IP address assigned
			Warning, but device still operational or firmware update
			Error, device not operational
			Self-test when switching on

Table 13: Power status LEDs







Location	Designation	LED behavior	Description
<ul style="list-style-type: none">  DEVICE  SENSOR / PoE  CAN 	DEVICE SENSOR/ PoE CAN		Voltage not applied to the connection.
			Voltage applied.
			Under/overvoltage detected.

Table 14: INC status LEDs







Location	Designation	LED behavior	Description
	PWR/ACT		Voltage not applied to the connection.
			Voltage applied. No signal activity.
			Voltage applied. Signal activity.
			Voltage not applied to the connection. Signal activity.
			Overvoltage or short-circuit detected. No signal activity.
			Overvoltage or short-circuit detected. Signal activity.

Table 15: SERIAL status LEDs







Location	Designation	LED behavior	Description
	PWR/ACT		Voltage not applied to the connection.
			Voltage applied. No signal activity.
			Voltage applied. Signal activity.
			Voltage not applied to the connection. Signal activity.
			Overvoltage or short-circuit detected. No signal activity.
			Overvoltage or short-circuit detected. Signal activity.

Table 16: FBUS status LEDs





Location	Designation	LED behavior	Description
	Link		Connection not established with fieldbus.
			Connection established with fieldbus.
	Act		No activity.
			Data transmission via fieldbus.

Table 17: CAN status LEDs



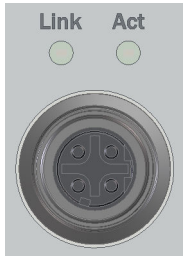



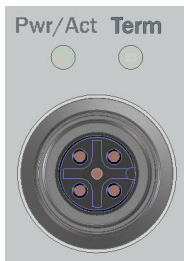

Location	Designation	LED behavior	Description
	PWR/ACT		Voltage not applied to the connection.
			Voltage applied. No signal activity.
			Voltage applied. Signal activity.
			Voltage not applied to the connection. Signal activity.
			Overvoltage or short-circuit detected. No signal activity.
			Overvoltage or short-circuit detected. Signal activity.
	Term		Termination resistor not activated.
		Termination resistor activated.	

Table 18: S1 to S8 status LEDs











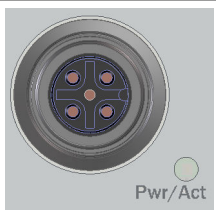

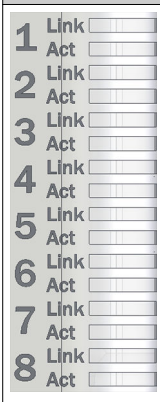

Location	Designation	LED behavior	Description
	PWR/ACT		Voltage not applied to the connection.
			Voltage applied. No signal activity.
			Voltage applied. Signal activity.
			Voltage not applied to the connection. Signal activity.
			Overvoltage or short-circuit detected. No signal activity.
			Overvoltage or short-circuit detected. Signal activity.

Table 19: ETHERNET status LEDs

Location	Designation	LED behavior	Description	
	Link		Connection not established with Ethernet.	
	Act		Connection established with Ethernet.	
	Act		No activity.	
	Act		Data transmission via Ethernet.	
	PoE		ETH1-ETH6 only: Voltage supply via Ethernet.	
	PoE		ETH1-ETH6 only: Error in supply line (overload, short-circuit)	
				

9 Maintenance

9.1 Cleaning



NOTICE

Equipment damage due to improper cleaning.

Improper cleaning may result in equipment damage.

- Only use recommended cleaning agents and tools.
- Never use sharp objects for cleaning.

- ▶ The device must be cleaned regularly from the outside to guarantee heat dissipation and therefore operation. Particular attention must be paid to ensure that the cooling ribs are free from dust and dirt. Clean using a dry towel or an industrial vacuum cleaner. Do not use cleaning agents.

9.2 Maintenance plan

During operation, the device works maintenance-free.

Depending on the assignment location, the following preventive maintenance tasks may be required for the device at regular intervals:

Table 20: Maintenance plan

Maintenance work	Interval	To be carried out by
Check device and connecting cables for damage at regular intervals.	Depends on ambient conditions and climate.	Specialist
Check that all unused connections are sealed with blind plugs.	Depends on ambient conditions and climate. Recommended: At least every 6 months.	Specialist

10 Decommissioning

10.1 Disposal

**CAUTION****Risk of injury due to hot device surface.**

The surface of the device can become hot during operation.

- Before commencing disassembly, switch off the device and allow it to cool down as necessary.

If a device can no longer be used, dispose of it in an environmentally friendly manner in accordance with the applicable country-specific waste disposal regulations. Do not dispose of the product along with household waste.

**NOTICE****Danger to the environment due to improper disposal of the device.**

Disposing of devices improperly may cause damage to the environment.

Therefore, observe the following information:

- Always observe the national regulations on environmental protection.
 - Separate the recyclable materials by type and place them in recycling containers.
-

11 Technical data



NOTE

The relevant online data sheet for your product, including technical data, dimensional drawing, and connection diagrams can be downloaded, saved, and printed from the Internet:

- www.sick.com/SIM4000

Please note: This documentation may contain further technical data.

11.1 Features

Feature	Parameter
Task	data recording, evaluation, and archiving
Supported devices/ excerpt	2D and 3D cameras from SICK or based on the GigE machine vision standard, encoders, code readers, SICK LiDAR scanners
Technology	Embedded hardware architecture: <ul style="list-style-type: none"> • 8 Core PowerPC CPU with AltiVec Velocity Engine • FPGA for image (pre-)processing • FPGA for I/O handling • Dedicated fieldbus controller Software: <ul style="list-style-type: none"> • Can be programmed within the SICK AppSpace environment • SICK Interface & Algorithm API • Integrated HALCON image processing library
Random Access Mem- ory	8 GB DDR4
Flash memory	1 GB NAND, 420 MB thereof available for applications
memory card (optional)	Industry-grade microSD memory card (flash card), max. 32 GB
application develop- ment kit	SICK AppStudio
Sensor data process- ing	based on HALCON and/or the SICK Algorithm API

11.2 Interfaces

Feature	Parameter
User interfaces	Web server (GUI), SICK AppStudio (programming), SICK AppManager (app installation, firmware update)
Data storage and retrieval	Image and data logging via optional internal SSD, microSD memory card, internal RAM and external FTP
SERIAL (RS-232/RS-422/RS-485)	
Quantity	2, also configurable as an encoder output port
Function	RS-232 / RS-422 / RS-485/ INC In/Out
maximum data transmis- sion rate	RS-232: 115.2 kBaud RS-422: 2 MBaud RS-485: 2 MBaud
INC (incremental)	
Quantity	2, also configurable as RS-422

Feature	Parameter
Function	Incremental encoder (In/OUT), RS-422 interface
Maximum frequency	2 MHz
FBUS (fieldbus)	
Quantity	2
Function	Ethernet-based fieldbus
Data transmission rate	10/100 MBit/s
Protocol	ProfiNet, Ethernet/IP, EtherCAT
ETHERNET	
Quantity	8
Function	Data output, configuration, firmware update, 6 x PoE PSE 12 W max.
Data transmission rate	- ETH1 – ETH6: 0.01; 0.1; 1 Gb/s with class 4 PoE - ETH7 – ETH8: 10 Gb/s (without PoE)
Protocol	TCP/IP, FTP (image transfer), OPC-UA, MQTT, GigE machine vision/ GenICAM
CAN	
Quantity	2
Function	SICK CAN sensor network (master/slave, multiplexer/server) with termination resistor which can be activated CAN functional modes: Mode 1: 2 separate CAN networks Mode 2: 1 CAN network with 2x power-out
Data transmission rate	20 kbit/s ... 1 Mbit/s
Protocol	CSN (SICK CAN sensor network)
IO-Link	
Quantity	4 (SENSOR S1 to S4)
Function	IO-Link Master V1.1
Data transmission rate	max. 230 kBaud
Digital switching inputs/outputs	
I/O	Inputs: 4 opto-decoupled, max. frequency: 30 kHz Inputs/outputs: 7 (configurable), max. frequency: 30 kHz
SENSOR S1-S4	Inputs: 1 each, max. frequency: 30 kHz Inputs/outputs: 1 each (configurable), max. frequency: 30 kHz
SENSOR S5-S8	Inputs: 1 each, max. frequency: 10 kHz Inputs/outputs: 2 each (configurable), max. frequency: 30 kHz
USB	USB 2.0 for configuration, diagnostics, firmware update

11.3 Mechanics and electronics

Feature	Parameter
Operating elements	1 selector switch, 1 function button (under the servicing panel)

Feature	Parameter
Electrical connection	I/O: 1 x M12, 17-pin female connector, A-coded POWER MAIN and CAN: 2 x M12, 4-pin male connector, T-coded INC: 2 x M12, 8-pin female connector, A-coded SERIAL: 2 x M12, 8-pin female connector, A-coded FBUS: 2 x M12, 4-pin female connector, D-coded CAN: 2 x M12, 5-pin female connector, A-coded SENSOR S1–S4, IO-Link master: 4 x M12, 5-pin female connector, A-coded SENSOR S5–S8: 4 x M12, 5-pin female connector, A-coded Ethernet GigE with POE: 6 x M12, 8-pin female connector, X-coded Ethernet 10GigE: 2x M12, 8-pin female connector, X-coded USB: Micro-B
Operating voltage	24 V DC, ± 10% SELV in accordance with EN 60950-1, also applies to digital switching inputs
Power consumption	60 W type, without connected sensors
Power output	Total 300 W max. (all connections)
Output current	
SENSOR S1-S8, I/O	≤ 100 mA, on digital output pins
SENSOR S1-S4	≤ 1 A, on power supply pins, LPS in accordance with EN 60950-1
SENSOR S5-S8	≤ 2.5 A, on power supply pins, LPS in accordance with EN 60950-1 Switching times when using the “Connector.Power.Gate” API: rise time/fall time/delay < 10 µs, max. frequency: 10 kHz
CAN	≤ 3.2 A, on power supply pins, LPS in accordance with EN 60950-1
SERIAL	≤ 1 A, on power supply pins, LPS in accordance with EN 60950-1
INC	≤ 0.5 A, on power supply pins, LPS in accordance with EN 60950-1
I/O	≤ 500 mA, on power supply pins, LPS in accordance with EN 60950-1
Housing material	Aluminum die cast
Housing color	Light blue (RAL 5012) with gray-white front foil (RAL 9002)
Protection class	III
Weight	5120 g
Dimensions (W x D x H)	164.5 x 147 x 272 mm

11.4 Ambient data

Feature	Parameter
Electromagnetic compatibility (EMC)	EN 61000-6-2:2005-08 EN 61000-6-4:2007 + A1:2011 EN 61131-9:2013-12
Shock resistance	EN 60068-2-6
Electrical safety	EN 60950-1:2006 + A11:2009 + A1:2010 + A12:2011 +AC: 2011 + A2:2013
Enclosure rating	IP65 in accordance with EN 60529-2000-09 (requires blind plugs to be inserted into unused connections)
Ambient operating temperature	0 °C ... +50 °C, when the described mounting requirements are taken into account, see "Mounting the device (at a critical ambient temperature of max. 50 °C)" , page 17

Feature	Parameter
Storage temperature	-20 °C ... +70 °C
Permissible relative humidity	90%, non-condensing

12 Annex

12.1 Dimensional drawings

All measurements in mm.

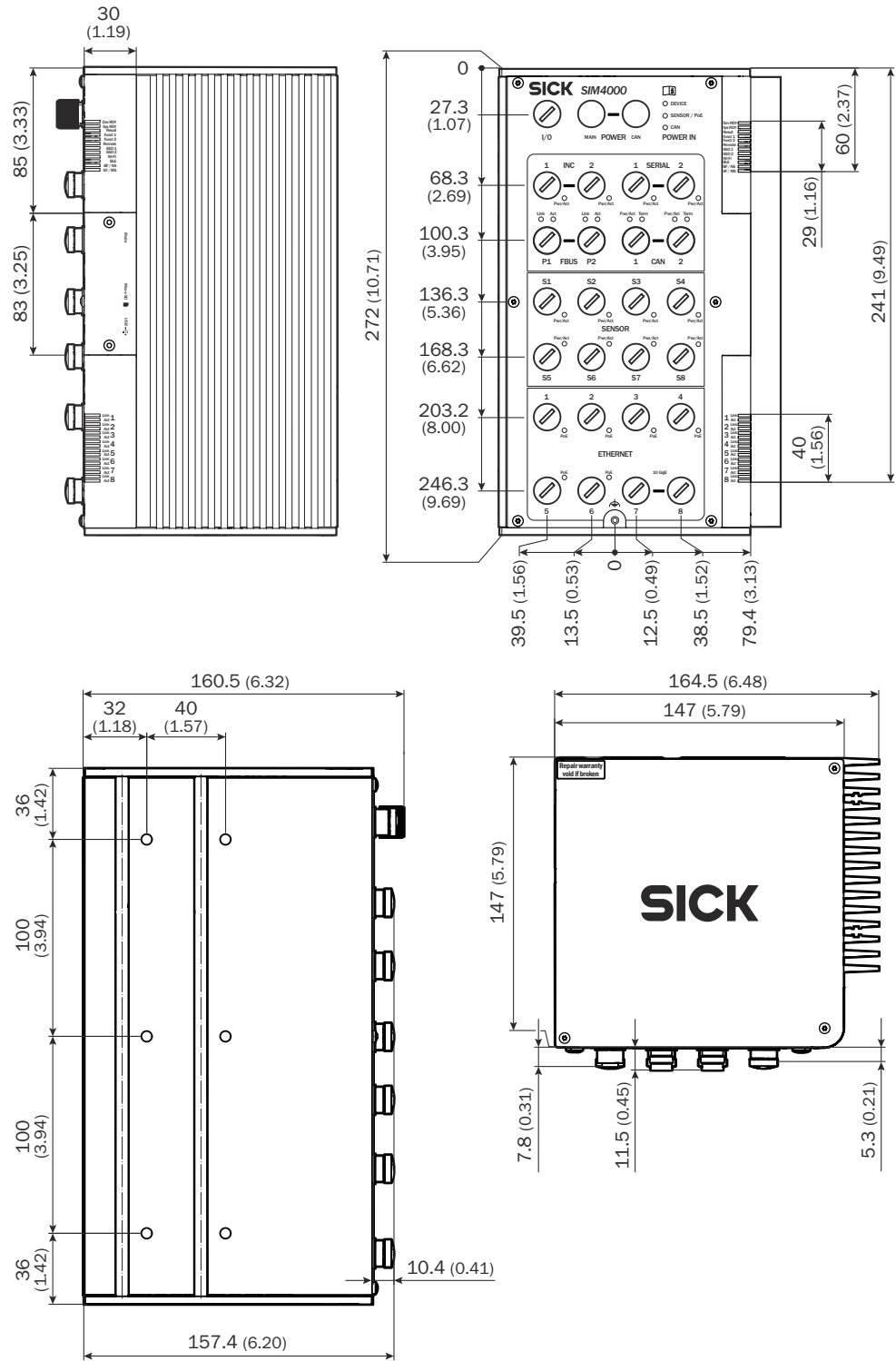

Adapter holding plate (available as accessory)

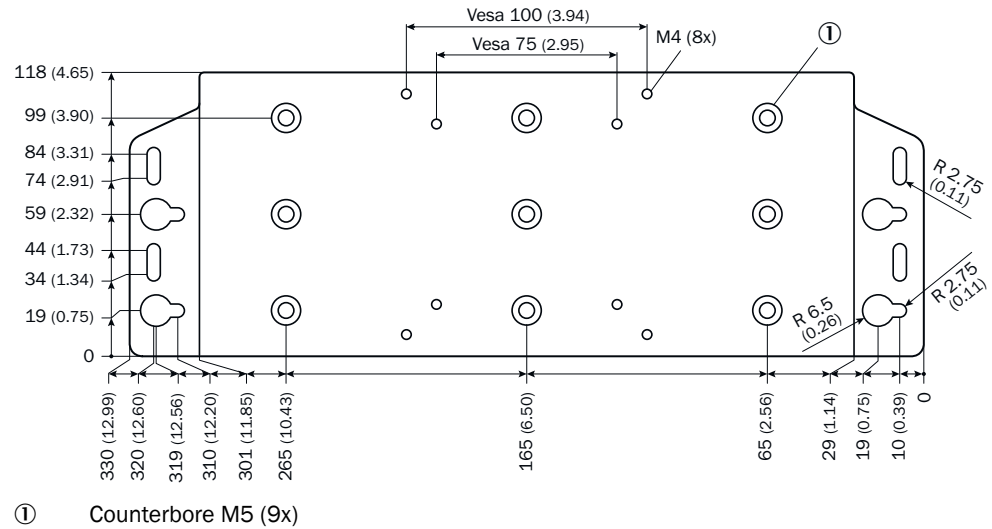

12.2 Licenses

SICK uses open source software which is published by the rights holders under a free license. Among others, the following license types are used: GNU General Public License (GPL version 2, GPL version 3), GNU Lesser General Public License (LGPL), MIT license, zlib license and licenses derived from the BSD license.

This program is provided for general use without warranty of any kind. This warranty disclaimer also extends to the implicit assurance of marketability or suitability of the program for a particular purpose.

More details can be found in the GNU General Public License. View the complete license texts here: www.sick.com/licensetexts. Printed copies of the license texts are also available on request.

Australia

Phone +61 (3) 9457 0600
1800 33 48 02 – tollfree
E-Mail sales@sick.com.au

Austria

Phone +43 (0) 2236 62288-0
E-Mail office@sick.at

Belgium/Luxembourg

Phone +32 (0) 2 466 55 66
E-Mail info@sick.be

Brazil

Phone +55 11 3215-4900
E-Mail comercial@sick.com.br

Canada

Phone +1 905.771.1444
E-Mail cs.canada@sick.com

Czech Republic

Phone +420 234 719 500
E-Mail sick@sick.cz

Chile

Phone +56 (2) 2274 7430
E-Mail chile@sick.com

China

Phone +86 20 2882 3600
E-Mail info.china@sick.net.cn

Denmark

Phone +45 45 82 64 00
E-Mail sick@sick.dk

Finland

Phone +358-9-25 15 800
E-Mail sick@sick.fi

France

Phone +33 1 64 62 35 00
E-Mail info@sick.fr

Germany

Phone +49 (0) 2 11 53 010
E-Mail info@sick.de

Greece

Phone +30 210 6825100
E-Mail office@sick.com.gr

Hong Kong

Phone +852 2153 6300
E-Mail ghk@sick.com.hk

Hungary

Phone +36 1 371 2680
E-Mail ertekesites@sick.hu

India

Phone +91-22-6119 8900
E-Mail info@sick-india.com

Israel

Phone +972 97110 11
E-Mail info@sick-sensors.com

Italy

Phone +39 02 27 43 41
E-Mail info@sick.it

Japan

Phone +81 3 5309 2112
E-Mail support@sick.jp

Malaysia

Phone +603-8080 7425
E-Mail enquiry.my@sick.com

Mexico

Phone +52 (472) 748 9451
E-Mail mexico@sick.com

Netherlands

Phone +31 (0) 30 229 25 44
E-Mail info@sick.nl

New Zealand

Phone +64 9 415 0459
0800 222 278 – tollfree
E-Mail sales@sick.co.nz

Norway

Phone +47 67 81 50 00
E-Mail sick@sick.no

Poland

Phone +48 22 539 41 00
E-Mail info@sick.pl

Romania

Phone +40 356-17 11 20
E-Mail office@sick.ro

Russia

Phone +7 495 283 09 90
E-Mail info@sick.ru

Singapore

Phone +65 6744 3732
E-Mail sales.gsg@sick.com

Slovakia

Phone +421 482 901 201
E-Mail mail@sick-sk.sk

Slovenia

Phone +386 591 78849
E-Mail office@sick.si

South Africa

Phone +27 10 060 0550
E-Mail info@sickautomation.co.za

South Korea

Phone +82 2 786 6321/4
E-Mail infokorea@sick.com

Spain

Phone +34 93 480 31 00
E-Mail info@sick.es

Sweden

Phone +46 10 110 10 00
E-Mail info@sick.se

Switzerland

Phone +41 41 619 29 39
E-Mail contact@sick.ch

Taiwan

Phone +886-2-2375-6288
E-Mail sales@sick.com.tw

Thailand

Phone +66 2 645 0009
E-Mail marcom.th@sick.com

Turkey

Phone +90 (216) 528 50 00
E-Mail info@sick.com.tr

United Arab Emirates

Phone +971 (0) 4 88 65 878
E-Mail contact@sick.ae

United Kingdom

Phone +44 (0)17278 31121
E-Mail info@sick.co.uk

USA

Phone +1 800.325.7425
E-Mail info@sick.com

Vietnam

Phone +65 6744 3732
E-Mail sales.gsg@sick.com

Detailed addresses and further locations at www.sick.com